

1

앞면만 코팅지로 코팅

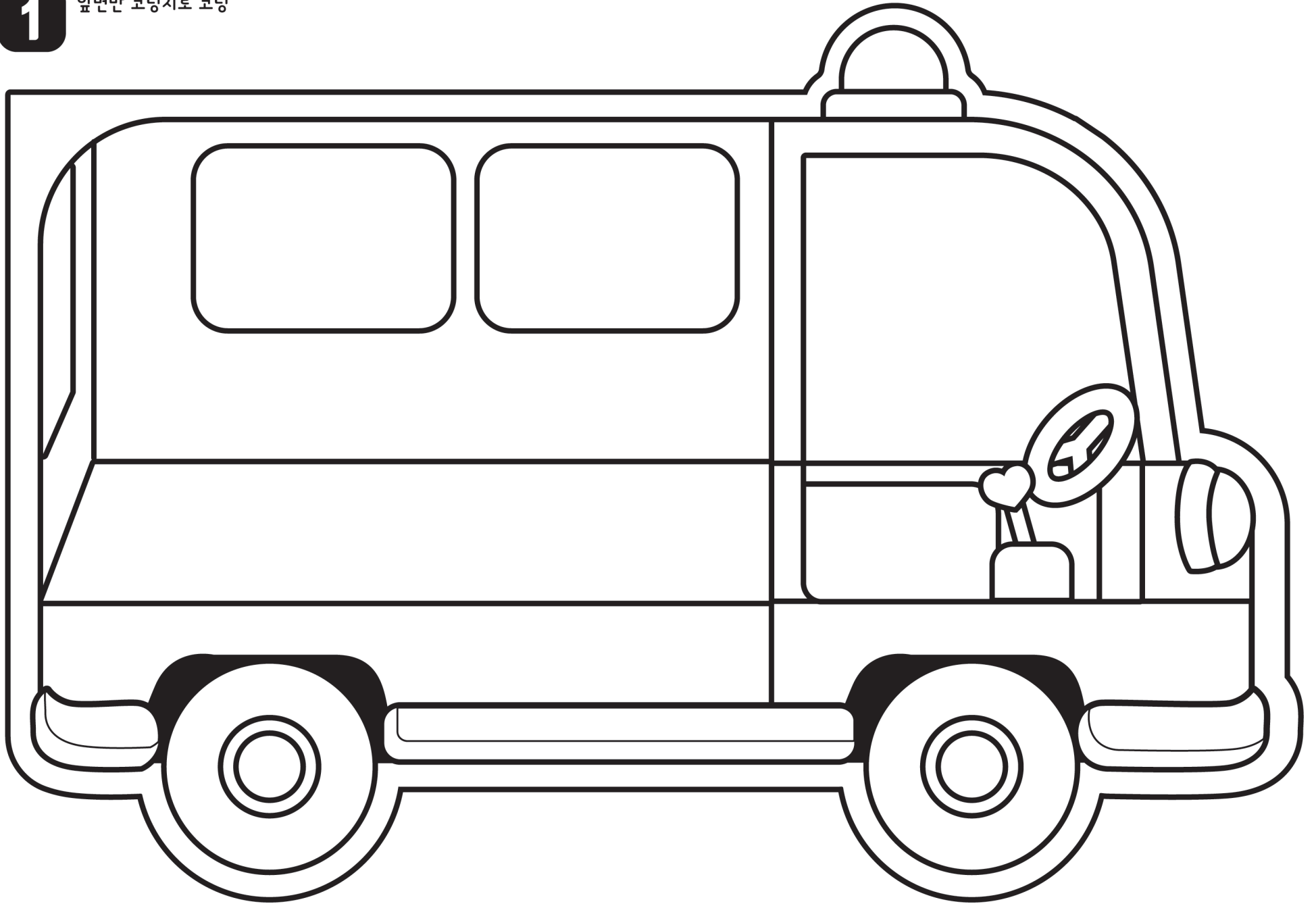

뚝뚝토이 ([https://blog.naver.com/seo\\_0607](https://blog.naver.com/seo_0607))

상업적으로 이용하시거나 2차수정은 안되요!(적발시 법적 책임을 질 수 있습니다)

2

앞면만 코팅지로 코팅

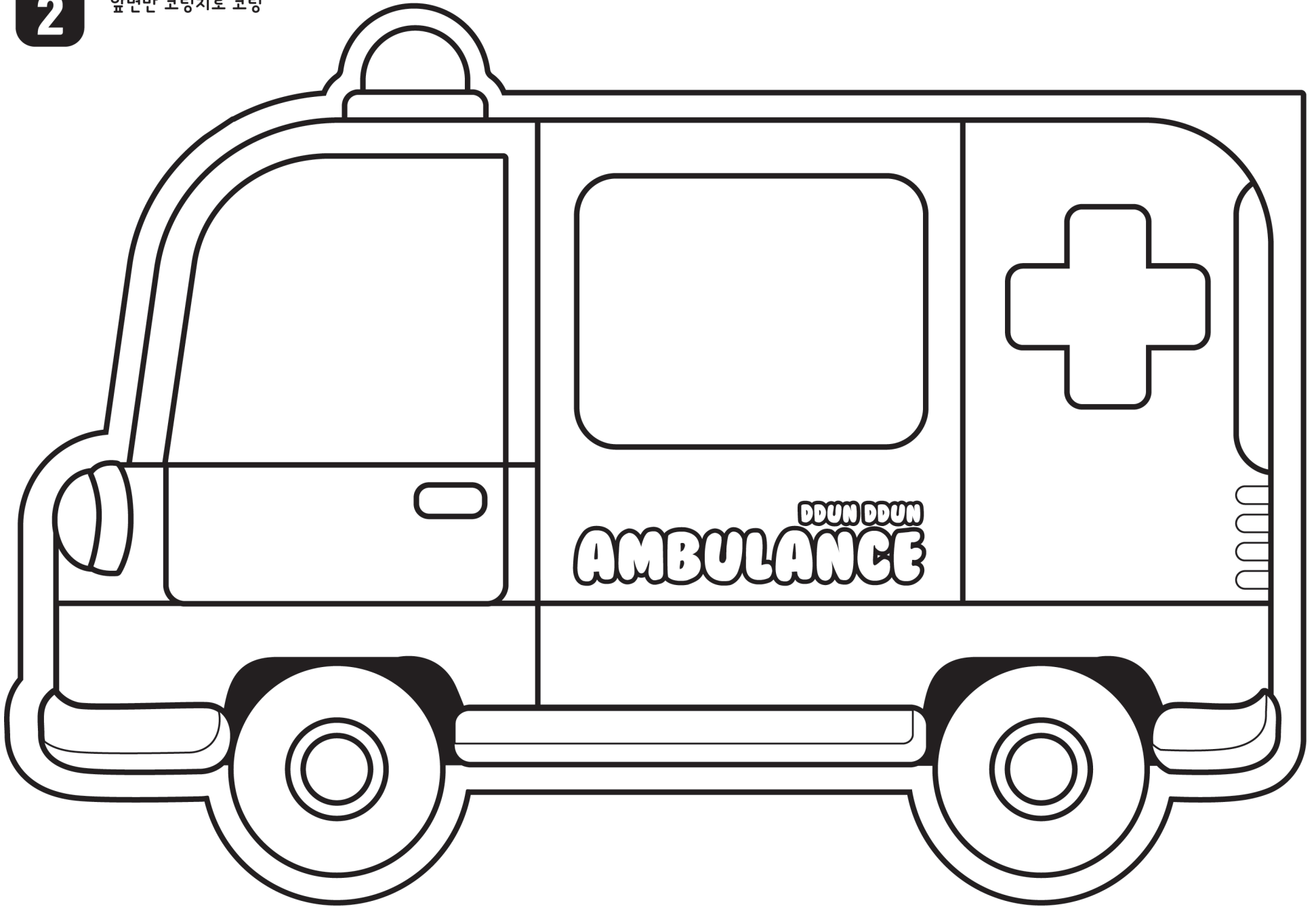

뚝뚝토이 ([https://blog.naver.com/seo\\_0607](https://blog.naver.com/seo_0607))

상업적으로 이용하시거나 2차수정은 안되요!(적발시 법적 책임을 질 수 있습니다)

3

앞면만 코팅지로 코팅

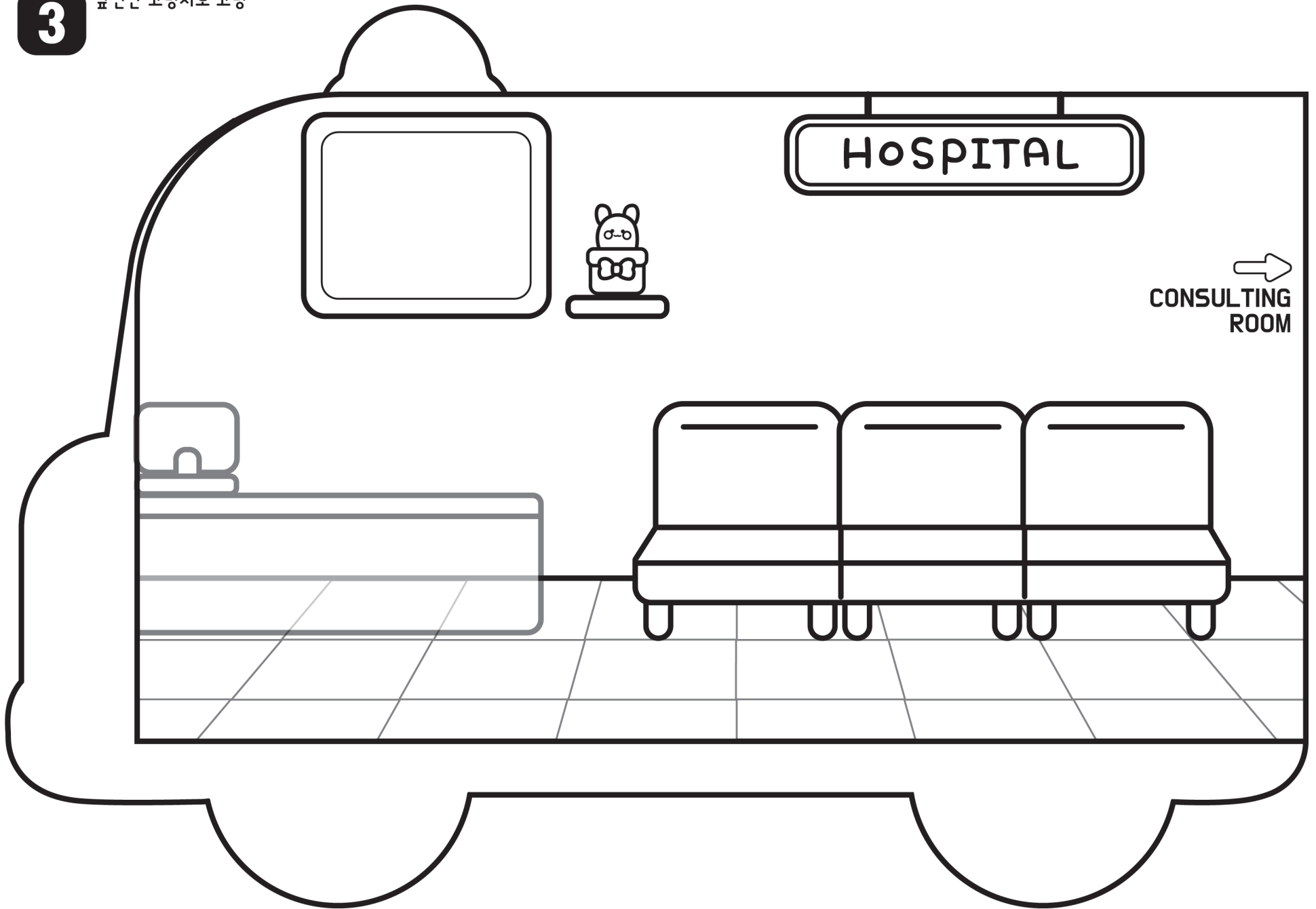

똥똥토이 ([https://blog.naver.com/seo\\_0607](https://blog.naver.com/seo_0607))

상업적으로 이용하시거나 2차수정은 안되요!(적발시 법적 책임을 질 수 있습니다)

4

앞면만  
코팅지로 코팅

똥똥토이 ([https://blog.naver.com/seo\\_0607](https://blog.naver.com/seo_0607)) 상업적으로 이용하시거나 2차수정은 안되요!(적발시 법적 책임을 질 수 있습니다)

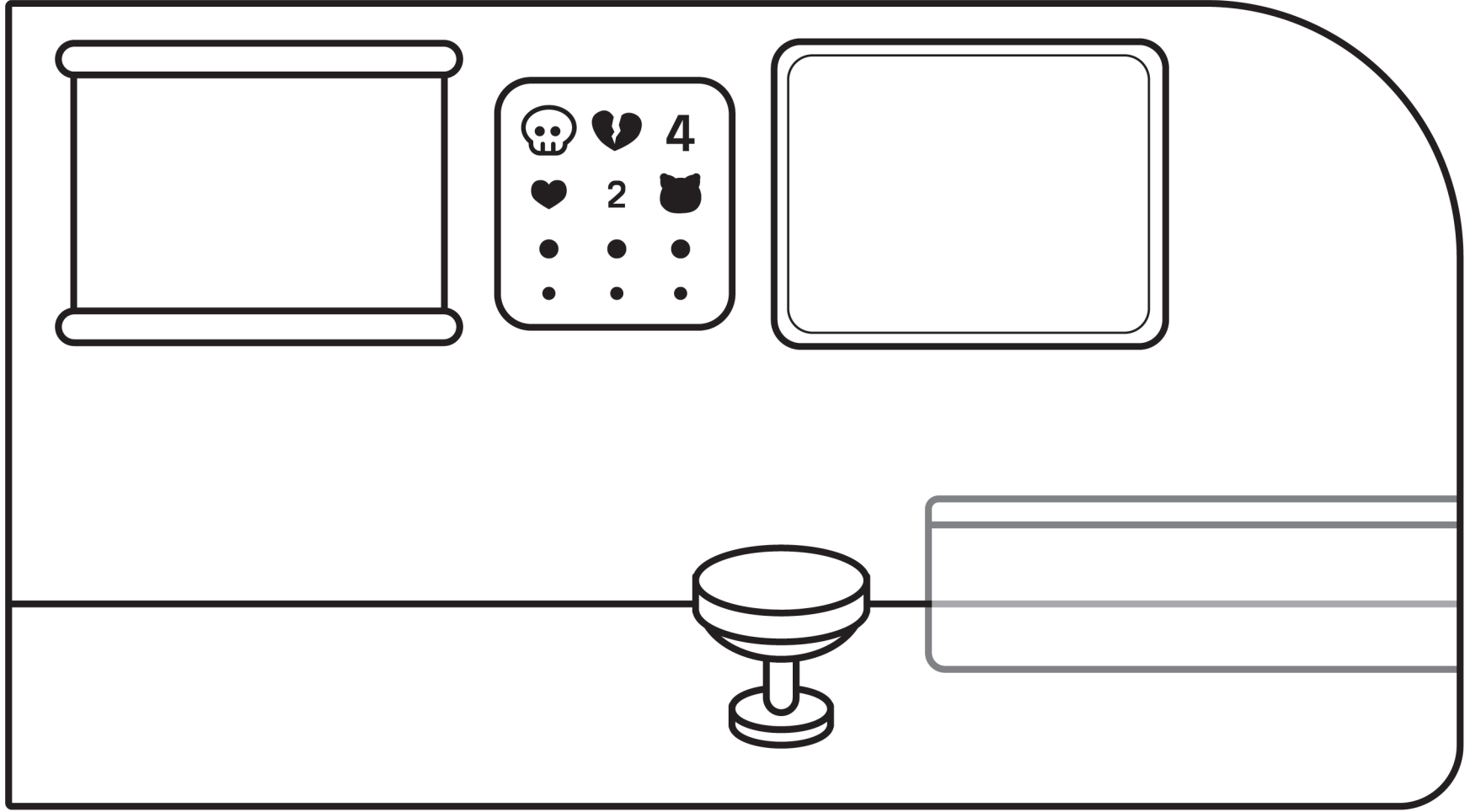

뒷면  
싯면  
테이프코팅

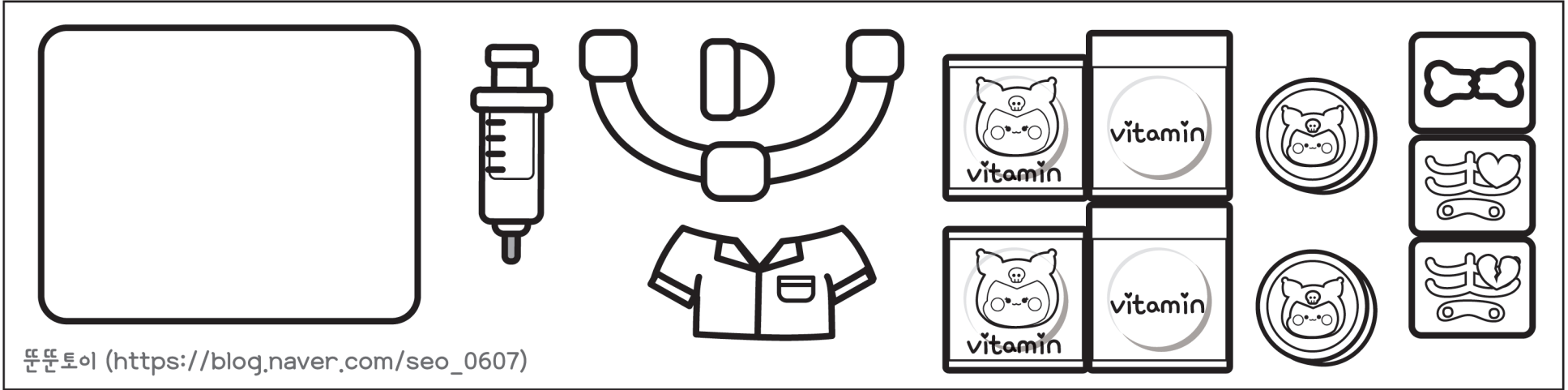

5

앞면만 코팅지로 코팅

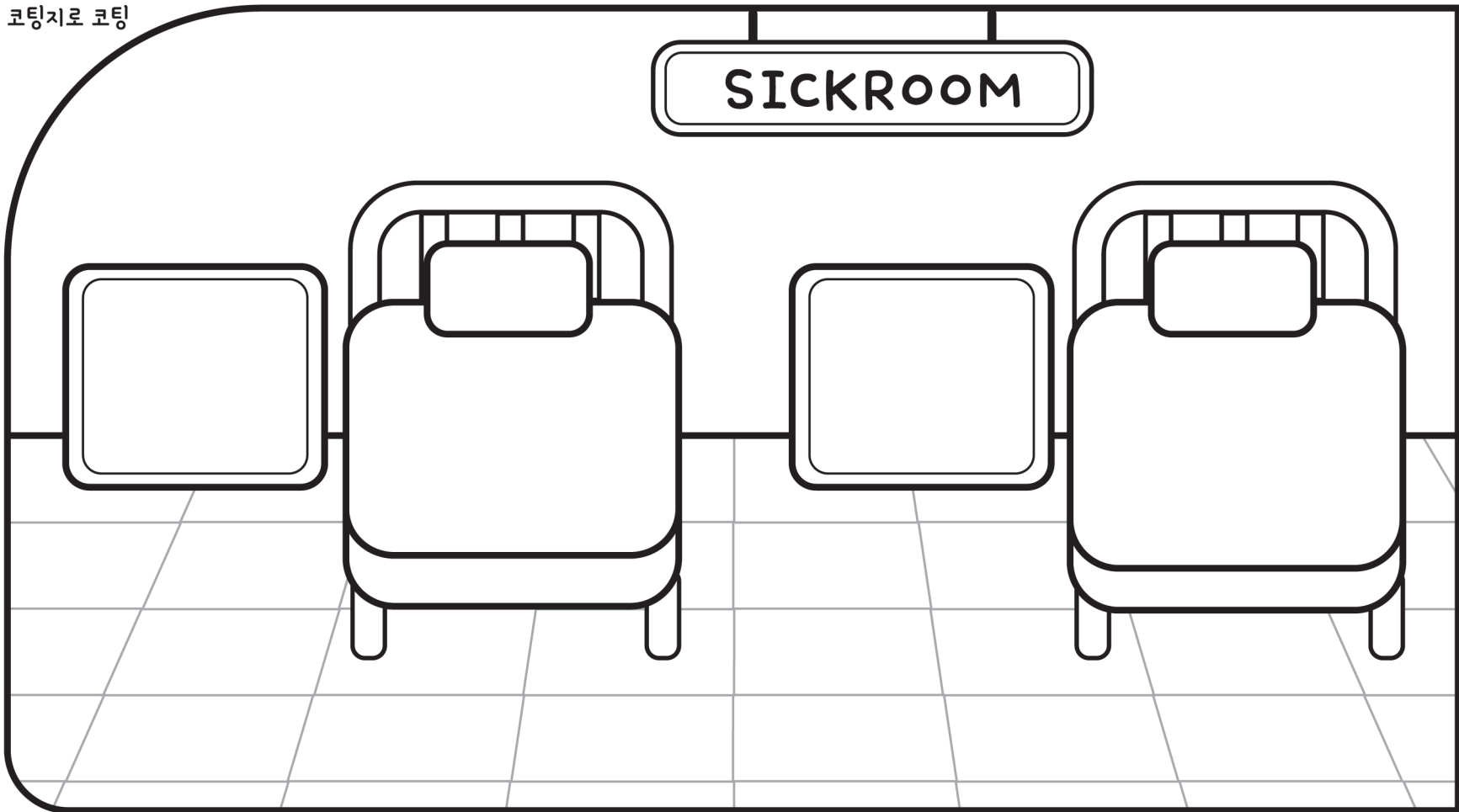

뒷면  
시트  
테이프코팅

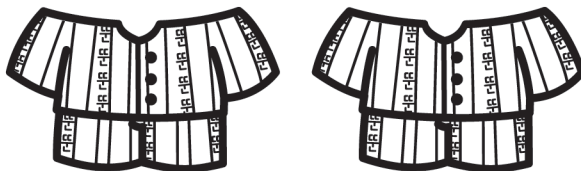
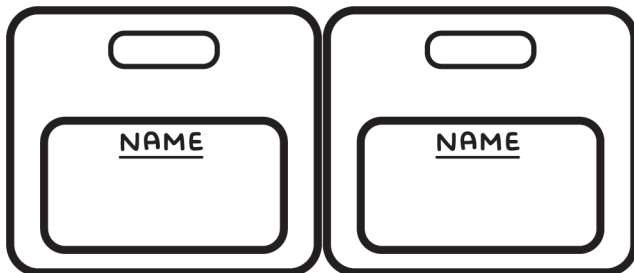
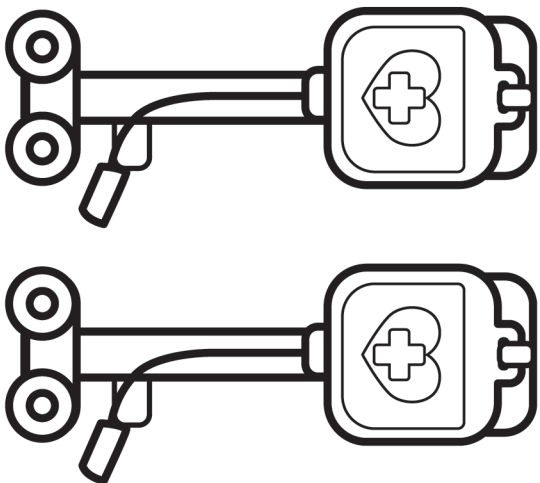

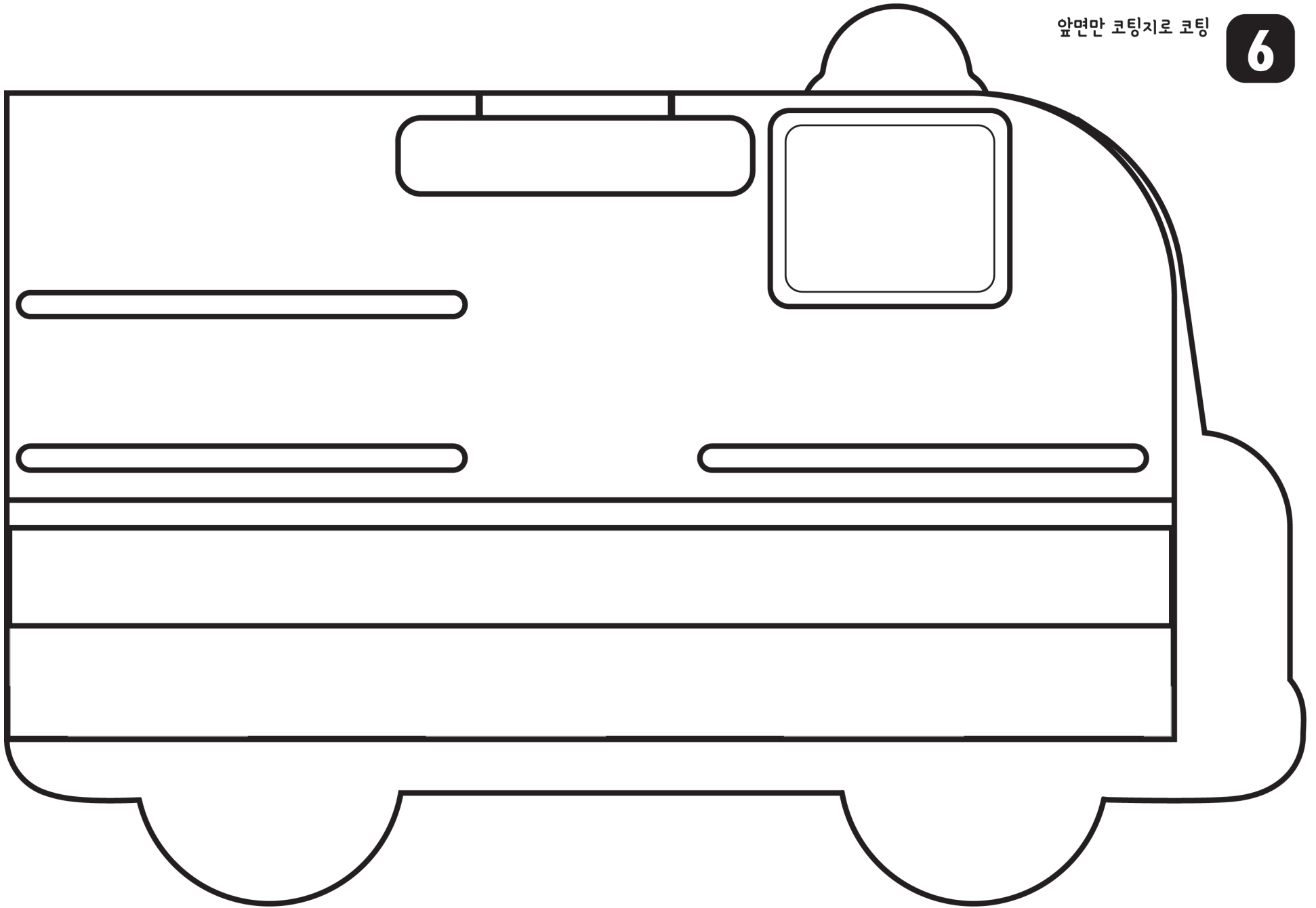



8

앞면코팅지  
뒷면 테이프코팅

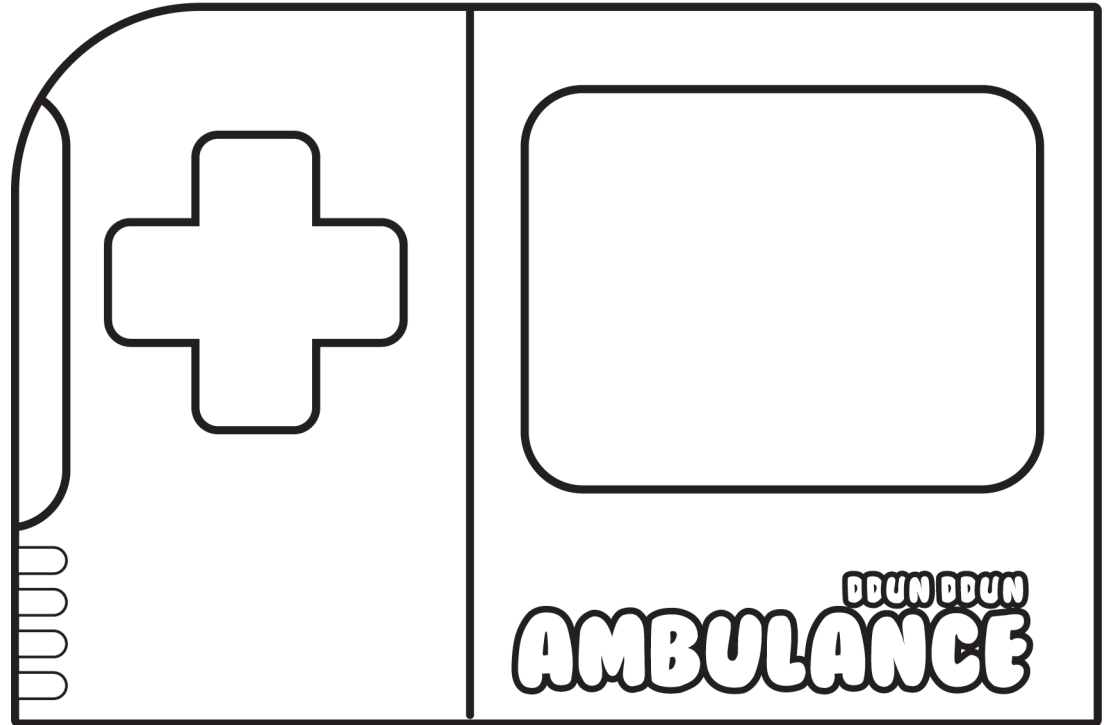
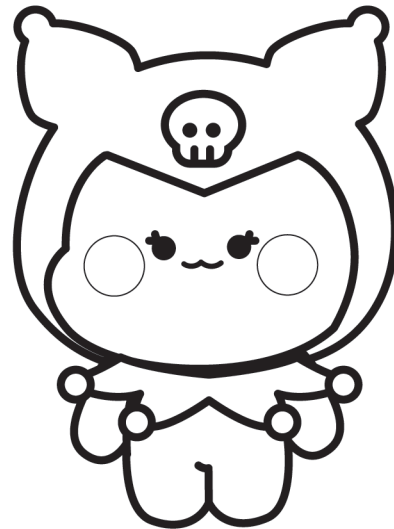
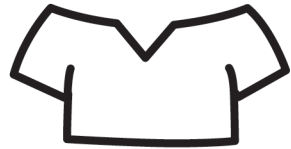
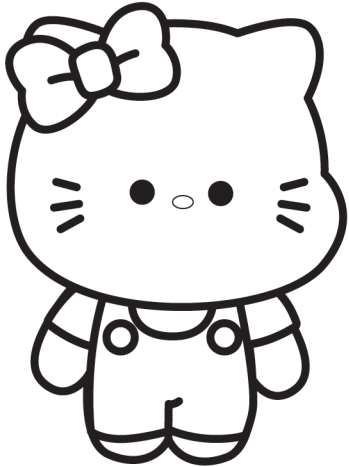

뚝뚝토이 ([https://blog.naver.com/seo\\_0607](https://blog.naver.com/seo_0607))  
상업적으로 이용하시거나 2차수정은 안되요!(적발시 법적 책임을 질 수 있습니다)